

Takler

NEWS 2009

## The search for harmony

represents the inner philosophy of Takler. Just like single notes in a symphony, every little detail has to be perfect in the whole.

Following this principle we have created an excellent product: a plastic insert for side protecting bars. What might seem in appearance just a simple piece of plastic, in reality, is absolutely

an innovative product. Characterized by an accurate design, the possibility to be personalized and at stable price, this item has become the “number one” in its field.



## GREY PLASTIC INSERT FOR BARS OF SIDE PROTECTION

COD	L	B	H	WEIGHT
TK1110	6500	100	30	2,600
TK1115	6500	200	30	4,550
TK1120	6500	300	30	7,150

mm - KG

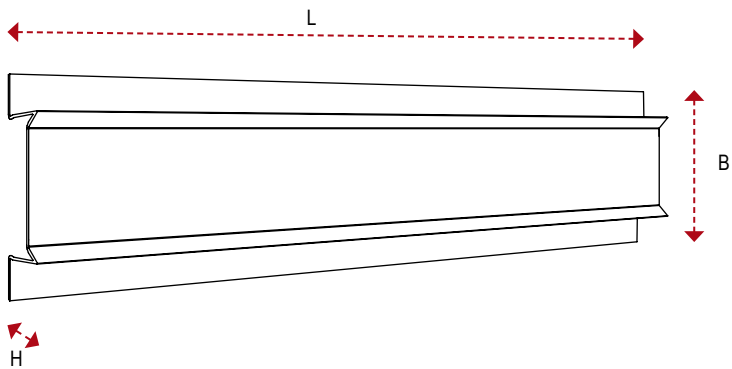

## BLACK PLASTIC INSERT FOR BARS OF SIDE PROTECTION

COD	L	B	H	WEIGHT
TK1111	6500	100	30	2,600
TK1116	6500	200	30	4,550
TK1121	6500	300	30	7,150

mm - KG

Realised in plastic material responding to special requests. It can be manufactured in different colours and personalised with logo.



## PLASTIC HEADER FOR SIDE PROTECTING BARS

COD	L	B	H	WEIGHT
TK1020	6500	90	105	4,900
TK1021	6500	90	105	4,900

mm - KG

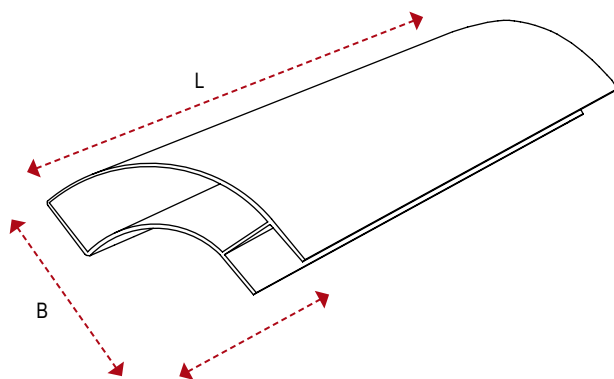

It can be easily fit with both plastic and aluminium bars. Its adjustable length guarantees an high versatility according to the needs and personalisation of the vehicle. Manufactured in grey and black colours, on demand, available in other colours.

## CAP FOR HEADERS

COD	L	B	H	WEIGHT
TK1080	140	100	28	0,04
TK1081	140	100	28	0,04

mm - KG

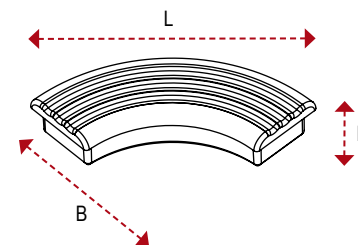

Wrapping cap, it completes the header finishing the edge. Available in two models: black and grey. On demand, it can be also produced in different colours.



## HOMOLOGATED THERMOPLASTIC CHOCK

COD	L	B	H	R	WEIGHT
TK2025	470	201	230	560	1,70
TK2026	470	201	225	560	1,55

mm - KG

Takler's chock with a brand new and functional design, it is made with completely automatized machines, guarantee of high quality. Both models, with and without metal insert are homologated in compliance with the DIN 76051 regulation.



TK2025



TK2026

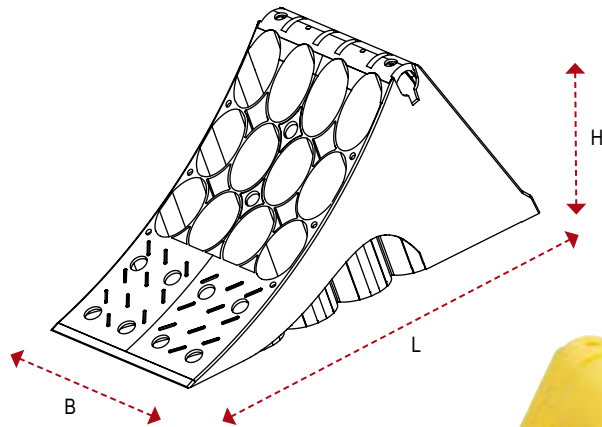

## FAST FIT CHOCK HOLDER

COD	L	B	H	WEIGHT
TK2051	235	202	240	1,09
TK2052	235	200	260	1,24

mm - KG

Versatile, light and strong. It makes easier the mounting of the chock holder without bolts and nuts.

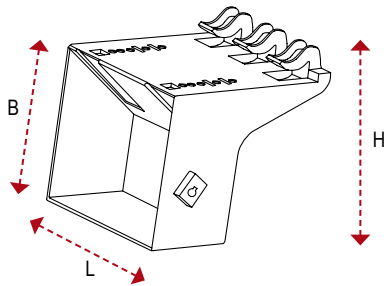

TK2051

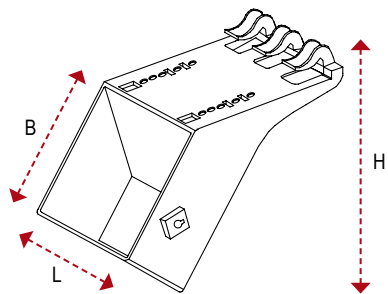

TK2052



## 50 LT PLASTIC WATER TANK

COD	L	B	H	WEIGHT
WHITE TK2530	458	453	470	3,60
BLACK TK2540	458	453	470	3,60

mm - KG

## 50 LT PLASTIC WATER TANK WITH SOAP HOLDER

COD	L	B	H	WEIGHT
WHITE TK2535	458	453	470	3,65
BLACK TK2545	458	453	470	3,65

mm - KG

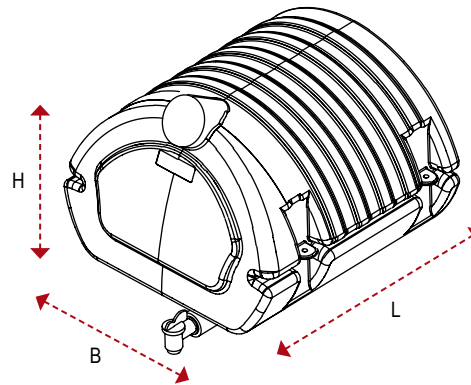

The plastic water tank is entirely manufactured with high technology machineries. It is characterised by its innovative design and fixing system with wrapping support. Available in white and black, on demand, it can be produced in other colours.

## HORIZONTAL ZINC PLATED PAIR OF BRACKETS FOR 50 LT WATER TANK 4mm

COD	L	B	H	WEIGHT
TK2560	410	71	164	3,40

mm - KG

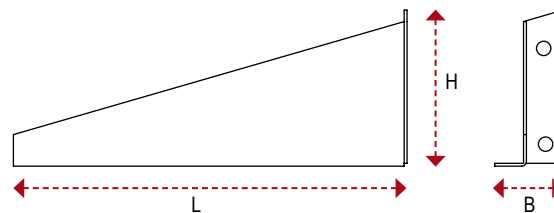

## **TAKLER SRL**

- ▶ VIA APPIA ANTICA, KM 13,100
  - ▶ JESCE INDUSTRIAL AREA
  - ▶ 75100 MATERA - ITALIA
  - ▶ TEL. +39 0835 251911 - FAX +39 0835 251966
  - ▶ P.IVA/C.F. 01122120775 - SHARE CAP € 1.000.000,00 i.v.
- [info@taklergroup.com](mailto:info@taklergroup.com)

## **FILIALE DEUTSCHLAND**

- ▶ IM ALTSEITERSTAL, 7
  - ▶ 66538 NEUNKIRCHEN - GERMANY
  - ▶ TEL. +49 06821 9722655 - FAX +49 06821 9722658
  - ▶ DE 260121647
- [info.de@taklergroup.com](mailto:info.de@taklergroup.com)

[www.taklergroup.com](http://www.taklergroup.com)